

Plunger Weight 可動鐵心重量 : 19g
Total Weight 總重量 : 96g

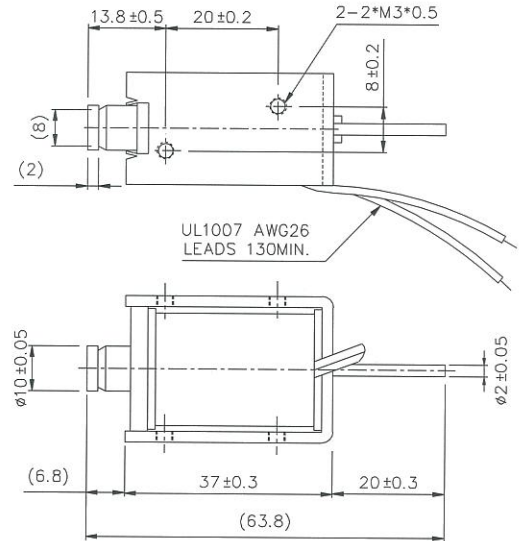

Shown Energized 通電狀態 UNIT 單位 : mm

STROKE Vs FORCE 行程 / 吸引力

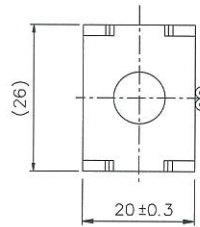
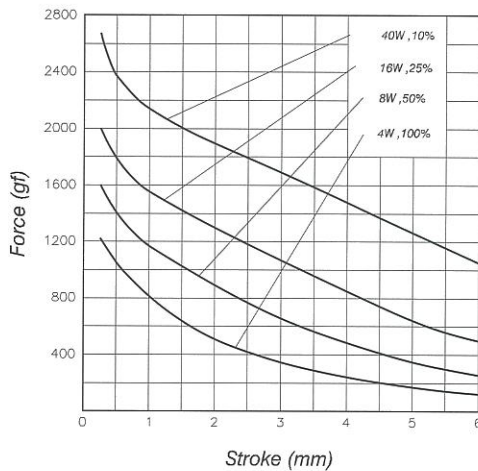

AMPERE-TURNS Vs FORCE 安-匝 / 吸引力

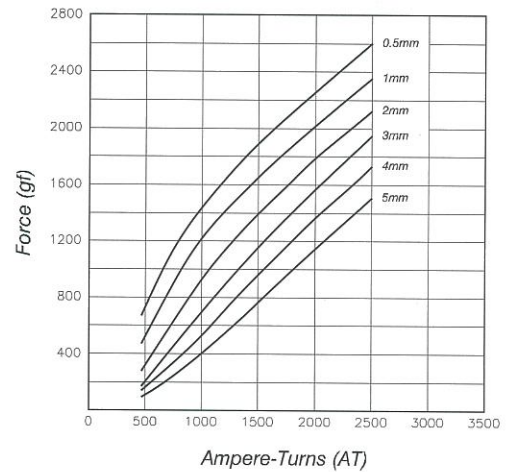

COIL DATA 線圈資料

Duty cycle (%) = $\frac{\text{"ON" time}}{\text{"ON" time} + \text{"OFF" time}} \times 100\%$		Continuous (100%)	Or less (50%)	Or less (25%)	Or less (10%)	
作動週期 (%) = $\frac{\text{ON 時間}}{\text{ON 時間} + \text{OFF 時間}} \times 100\%$		連續 (100%)	間斷 (50%)	間斷 (25%)	間斷 (10%)	
MAX. "on" time in seconds 最大 ON 時間 (秒)		∞	100	36	7	
Watts at 20°C 瓦特數 (W) (在 20°C)		4	8	16	40	
Ampere-turns at 20°C AT 值 (在 20°C)		600	850	1200	1900	
Type no.	Resistance (20°C) Ω ± 10%	No. turns	Volts DC			
型號	阻值 (Ω) ± 10%	繞線圈數	電壓			
SMO-1037S06AA	9	980	6	8.5	12	19
SMO-1037S12AA	36	1700	12	17	24	38
SMO-1037S24AA	144	3600	24	34	48	76
SMO-1037S48AA	576	7300	48	68	96	152